

RIGID (STATIONARY) CEILING COLUMN APPROVAL BOOKLET



TABLE OF CONTENTS

Product Description	3
Cleaning	3
Inspection and Testing	3
Elevation View	4
Optional Accessory Chart	5
Bottom View	6
Electrical Diagram	7
Mounting Plate to Outlet Detail	8
Mounting Information	9
Typical Location View	10

PRODUCT DESCRIPTION

The Rigid ceiling column shall be an Amico Alert-1 series.

The shroud is made of 16 gauge stainless steel with a #4 satin finish consisting of a: removable access panel, stainless steel ceiling collar and a heavy gauge steel mounting plate.

All electrical services are provided by means of liquid tight flex metal conduits and gas services are type K, oxygen cleaned copper pipes. Standard dimensions are 12" X 12".

NOTE: Electrical devices are pre-wired, unless other wise stated. All conduits and wires will extend 36" above finish column for main connections to the source. Gases will be manifolded for single point connections to the source. All pipes will extend 8" from the top of mounting plate.

CLEANING

The Amico Outlets are factory cleaned for oxygen service. Exposed surfaces of the outlet may be cleaned with a mild detergent solution or wiped with a disinfectant commonly used in patient rooms that is compatible with plastics, anodized aluminium and die cast zinc.

INSPECTION AND TESTING

Medical Gas Outlets should be inspected periodically or at least once a year. The test should be in accordance with NFPA 99-93 "*Gas and Vacuum systems*", or CSA Z305.1-92 "*Nonflammable Medical Gas Piping System*".

Test for leaks: Ensure that no leaks exist, with or without the adapter inserted.

Test for Indexing: Only a mating gas specific adapter should insert smoothly into the outlet, latch and be retained.

Test for Flow:

- Gas Outlets: 120 l/min (4.2 scfm) @ 345 kPa (50 psi), maximum allowable pressure drop is 28 kPa (4 psi).
- Nitrogen Outlet: 400 l/min (14.1 scfm) @ 1,250 kPa (180 psi), maximum allowable pressure drop is 70 kPa (10 psi).
- Vacuum Outlet: 30 l/min (1.1 scfm) @ 54 kPa (16 inHg), maximum allowable pressure drop is 13 kPa (4 inHg).

Refer to the appropriate standards for the proper way of performing the flow test.

Note: The Amico medical gas and vacuum outlets meet and exceed these requirements at the time of manufacture. However piping source capacity, sizing and restrictions may prevent outlets from attaining these values.

RIGID CEILING COLUMN ELEVATION VIEW

To accommodate different ceiling heights, Amico Corporation has standardized ten different variations.
The column lengths range from 15"(381mm) to 42"(1067mm), with three inch(76mm) increments between all sizes.

Please select the required column height below .

L1=COLUMN HEIGHT

- 15"(381 mm)
- 18"(457 mm)
- 21"(533 mm)
- 24"(610 mm)
- 27"(686 mm)
- 30"(762 mm)
- 33"(838 mm)
- 36"(914 mm)
- 39"(991 mm)
- 42"(1067 mm)

CEILING HEIGHT IS

COLUMN HEIGHT IS:

QTY.=

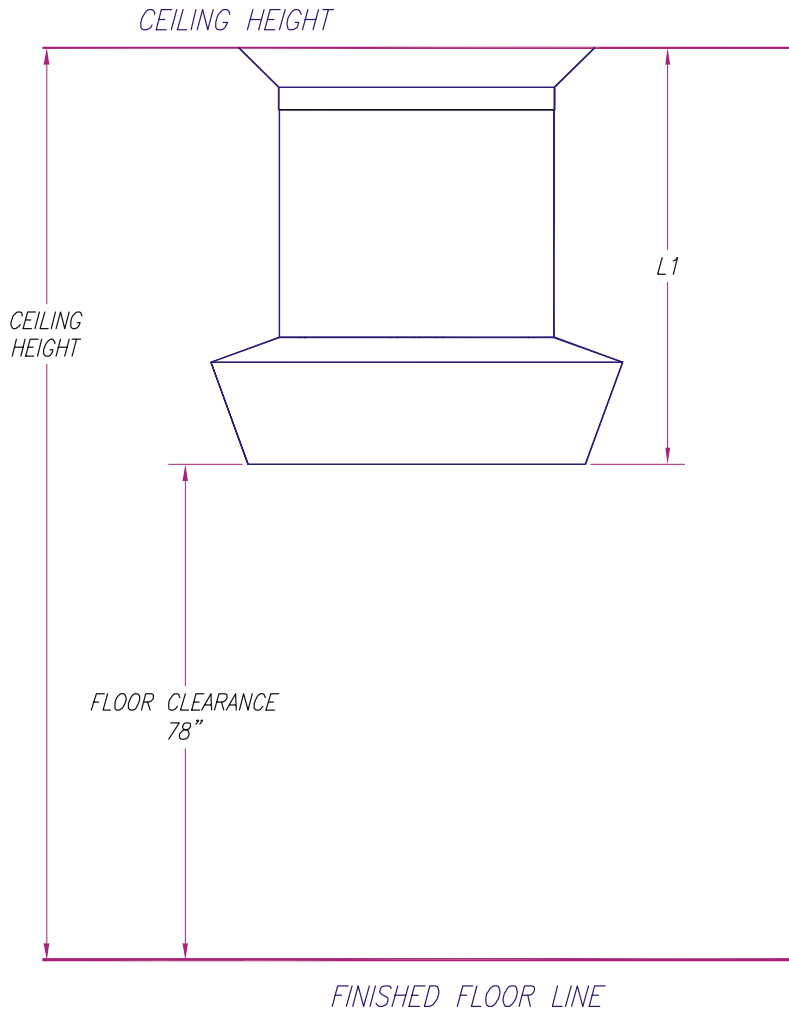

APPROVAL SIGNATURE _____

DATE _____









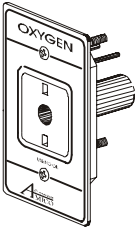

PHONE NO. _____

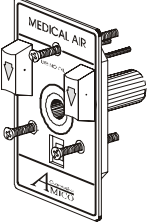
Amico Corporation
85 Fulton Way
Richmond Hill, Ontario
L4B 2N4, CANADA
Tel: (905) 764-0800
Fax: (905) 764-0862
www.amico.com

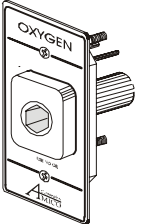
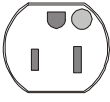
HOSPITAL _____
LOCATION _____
DRAWING NO: _____

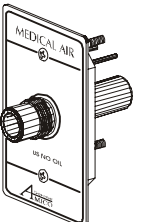
MODEL: RIGID CEILING COLUMN
DESCRIPTION: ELEVATION VIEW
REVISION NUMBER: _____ DATE: _____

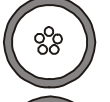
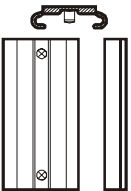
OPTIONAL ACCESSORY CHART

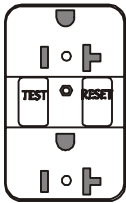
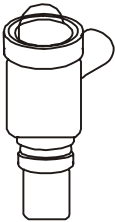
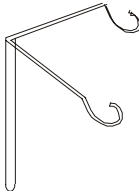
 <p style="text-align: right;">QD XXX</p> <p style="text-align: center;">Ohmeda / Medaes Compatible</p>		 <p style="text-align: right;">E9-RED E10-IVO.</p> <p style="text-align: center;">Duplex Receptacle 8300-HG 125V/20a (US / International)</p>
 <p style="text-align: right;">CH XXX</p> <p style="text-align: center;">Chemetron Compatible</p>	 <p style="text-align: right;">E3-RED E4-IVO.</p> <p style="text-align: center;">Single Receptacle 8310CN-HG 125V/20a (Canadian 15a)</p>	 <p style="text-align: right;">E11-RED E12-IVO.</p> <p style="text-align: center;">Single Receptacle 8310-HG 125V/20a (US / International)</p>
 <p style="text-align: right;">PB XXX</p> <p style="text-align: center;">Puritan-Bennett Compatible</p>	 <p style="text-align: right;">E5-RED E6-IVO.</p> <p style="text-align: center;">Duplex Receptacle 8200-HG 125V/15a (US / International)</p>	 <p style="text-align: right;">GJ</p> <p style="text-align: center;">Ground Jack Receptacle Single Hampden (SLR-3) GREEN</p>
 <p style="text-align: right;">DI XXX</p> <p style="text-align: center;">DISS</p>	 <p style="text-align: right;">E7-RED E8-IVO.</p> <p style="text-align: center;">Single Receptacle 8210-HG 125V/15a (US / International)</p>	 <p style="text-align: right;">MJ</p> <p style="text-align: center;">Monitor Jack Duplex (5-pin shown)</p>
 <p style="text-align: right;">SL</p> <p style="text-align: center;">Vacuum Bottle Slide</p>	 <p style="text-align: right;">TL</p> <p style="text-align: center;">Twist-Lock Receptacle Hubble 23000-HG 125V/20a</p>	 <p style="text-align: right;">E13-RED E14-IVO. E13C-RED E14C-IVO.</p> <p style="text-align: center;">Ground Fault Circuit Interrupter (C = Canadian)</p>
 <p style="text-align: right;">EVAC</p> <p style="text-align: center;">Passive Evacuation with Impedance Valve (19mm/22mm)</p>	<p style="text-align: right;">DJ</p> <p style="text-align: center;">Data - Telephone Communication Jack (Provision only)</p>	<p style="text-align: right;">IV</p>  <p style="text-align: center;">Stainless Steel IV Hook (Duplex only)</p>

All electrical devices are HUBBELL brand

RIGID CEILING COLUMN BOTTOM VIEW

ACCESS PANEL ON THIS SIDE

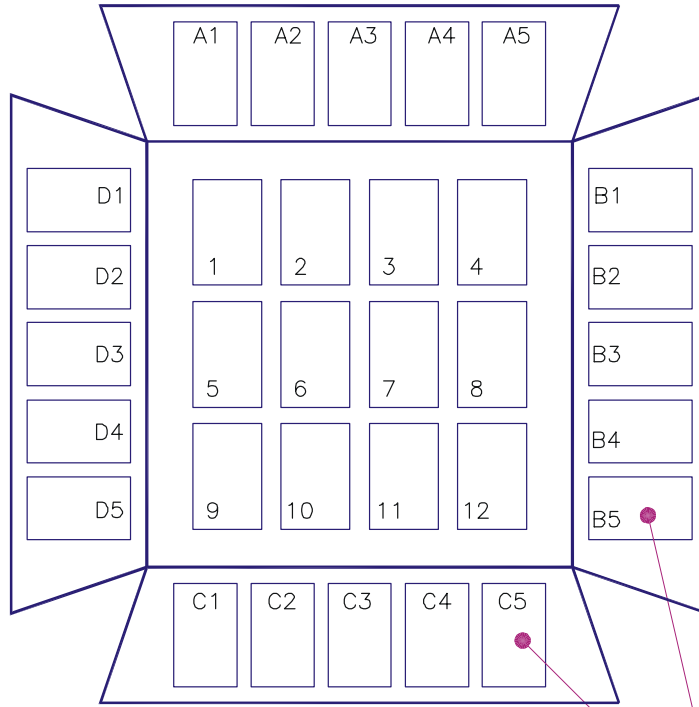

*BOTTOM VIEW
LOOKING UP*

"SEE NOTE NO. 1"

PLEASE FILL OUT THE OPTIONAL DEVICES THAT YOU REQUIRE FOR YOUR APPLICATION.

*POSITIONS 1-12 = MEDICAL GAS OUTLETS
POSITIONS A1-D5 = ELECTRICAL AND/OR
COMMUNICATION DEVICES*

NOTE:
*TWO ELECTRICAL/COMMUNICATION DEVICES CANNOT
BE PLACED TOGETHER AT ANY CORNER.*

APPROVAL SIGNATURE

DATE

PHONE NO.

A Corporation
AMICO
85 Fulton Way
Richmond Hill, Ontario
L4B 2N4, CANADA
Tel: (905) 764-0800
Fax: (905) 764-0862
www.amico.com

HOSPITAL

LOCATION

DRAWING NO:

MODEL:

RIGID CEILING COLUMN

DESCRIPTION:

BOTTOM VIEW

REVISION NUMBER: _____ DATE: _____

RIGID CEILING COLUMN ELECTRICAL DIAGRAM

ACCESS PANEL ON THIS SIDE

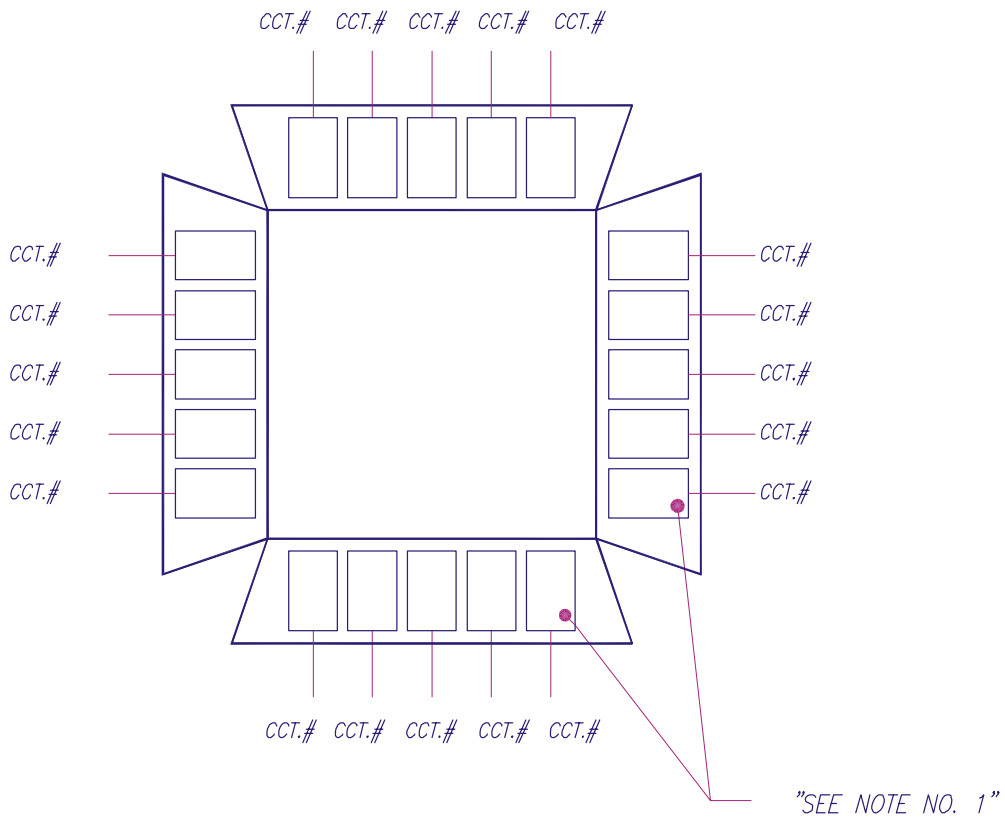

Pls. Specify Electrical Details:

-Type of Wire: _____

-AWG Wire Gauge: _____

-Circuit Number(CCT#) for each receptacle.

NOTE:

1. TWO ELECTRICAL/COMMUNICATION DEVICES CANNOT BE PLACED TOGETHER AT ANY CORNER.
2. IF TYPE OF WIRE & SIZE IS NOT SPECIFIED USE THE FOLLOWING:
FOR US/INTERNATIONAL
- 12 Ga. THHN WIRE (STD. WIRING)
- 10 Ga. THHN WIRE (ALL GROUNDS)
FOR CANADA:
- 12 Ga. RW90 WIRE (STD. WIRING)
- 10 Ga. RW90 WIRE (ALL GROUNDS)
3. CONDUIT: 1/2" FLEXIBLE CONDUIT.
4. ALL CONDUITS AND WIRES WILL EXTEND 36" ABOVE FINISH COLUMN FOR CONNECTION TO MAIN SOURCE.

APPROVAL SIGNATURE _____

DATE _____

PHONE NO. _____

AMICO Corporation
85 Fulton Way
Richmond Hill, Ontario
L4B 2N4, CANADA
Tel: (905) 764-0800
Fax: (905) 764-0862
www.amico.com

HOSPITAL _____

LOCATION _____

DRAWING NO: _____

MODEL:

RIGID CEILING COLUMN

DESCRIPTION:

ELECTRICAL DIAGRAM

REVISION NUMBER: _____ DATE: _____

RIGID CEILING COLUMN MOUNTING PLATE TO OUTLET DETAIL

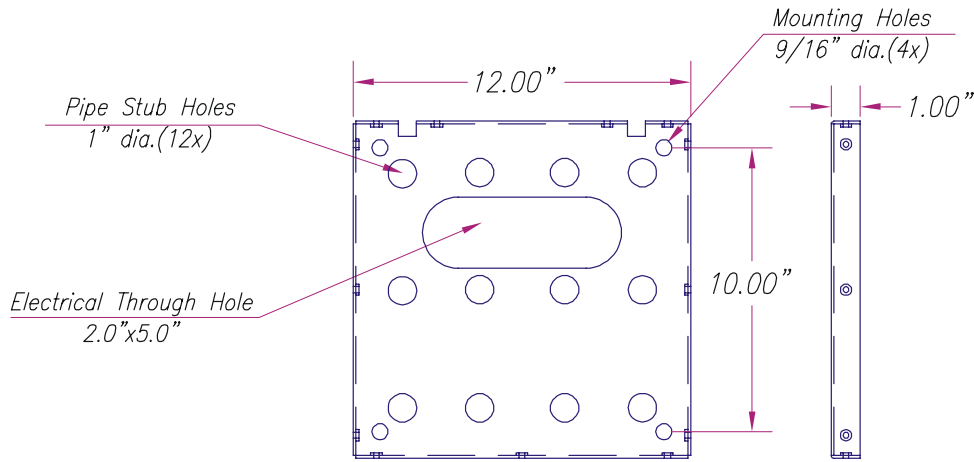

TOP VIEW
MOUNTING PLATE

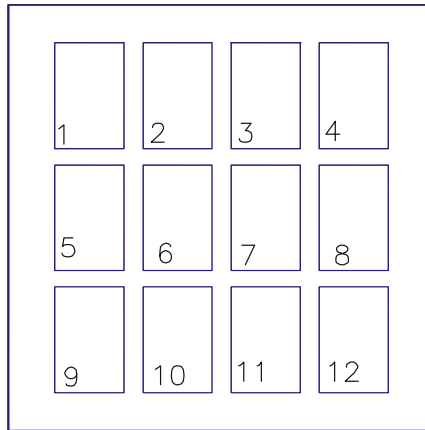

BOTTOM VIEW

NOTE:

1. GASES WILL BE MANIFOLDED FOR SINGLE POINT CONNECTIONS FROM SOURCE.
2. ALL PIPES WILL EXTEND 8" FROM THE TOP OF MOUNTING PLATE.
3. PIPE STUBS DIAMETERS ARE:
 - 3/4" DIA. FOR VACUUM, WAGD AND AGSS
 - 1/2" DIA. FOR MEDICAL AIR, OXYGEN, NITROUS OXIDE AND NITROGEN.
4. EXACT LOCATIONS OF GAS TERMINATIONS ON MOUNTING PLATE WILL BE DETERMINED AFTER RECEIVING THIS BOOKLET. AMICO WILL FOLLOW ASAP WITH A COMPLETE "MOUNTING PLATE TO OUTLET DETAIL" DIAGRAM, SHOWING EXACT LOCATIONS FOR GAS TERMINATIONS.

APPROVAL SIGNATURE _____

DATE _____

PHONE NO. _____



85 Fulton Way
Richmond Hill, Ontario
L4B 2N4, CANADA
Tel: (905) 764-0800
Fax: (905) 764-0862
www.amico.com

HOSPITAL _____

LOCATION _____

DRAWING NO: 020326-04

MODEL: _____

RIGID CEILING COLUMN

DESCRIPTION: _____

MOUNTING PLATE TO OUTLET DETAIL

REVISION NUMBER: _____ DATE: _____

RIGID CEILING COLUMN MOUNTING INFORMATION

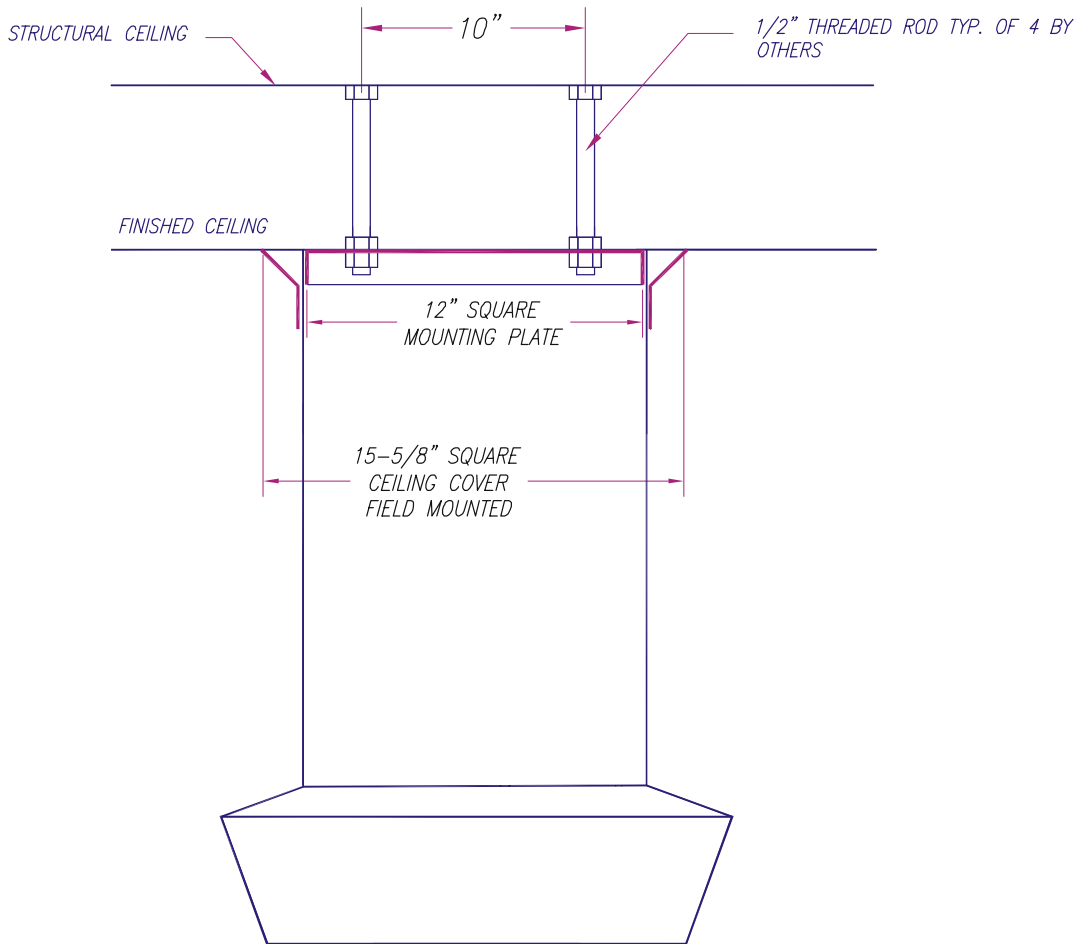

NOTES

1. 1/2" Support rods located for total support of fixture (minimum 400lb. load), all labor and materials for support fabrication including nuts and washers for installation supplied by General Contractor.
2. General Contractor has final responsibility for the strength and stability of the mounting structure.
3. Mounting structure and all hardware necessary supplied by General Contractor.

APPROVAL SIGNATURE

DATE

PHONE NO.



www.amico.com

HOSPITAL

LOCATION

DRAWING NO:

MODEL:

RIGID CEILING COLUMN

DESCRIPTION:

MOUNTING INFORMATION

REVISION NUMBER: _____ DATE: _____

TYPICAL LOCATION VIEW

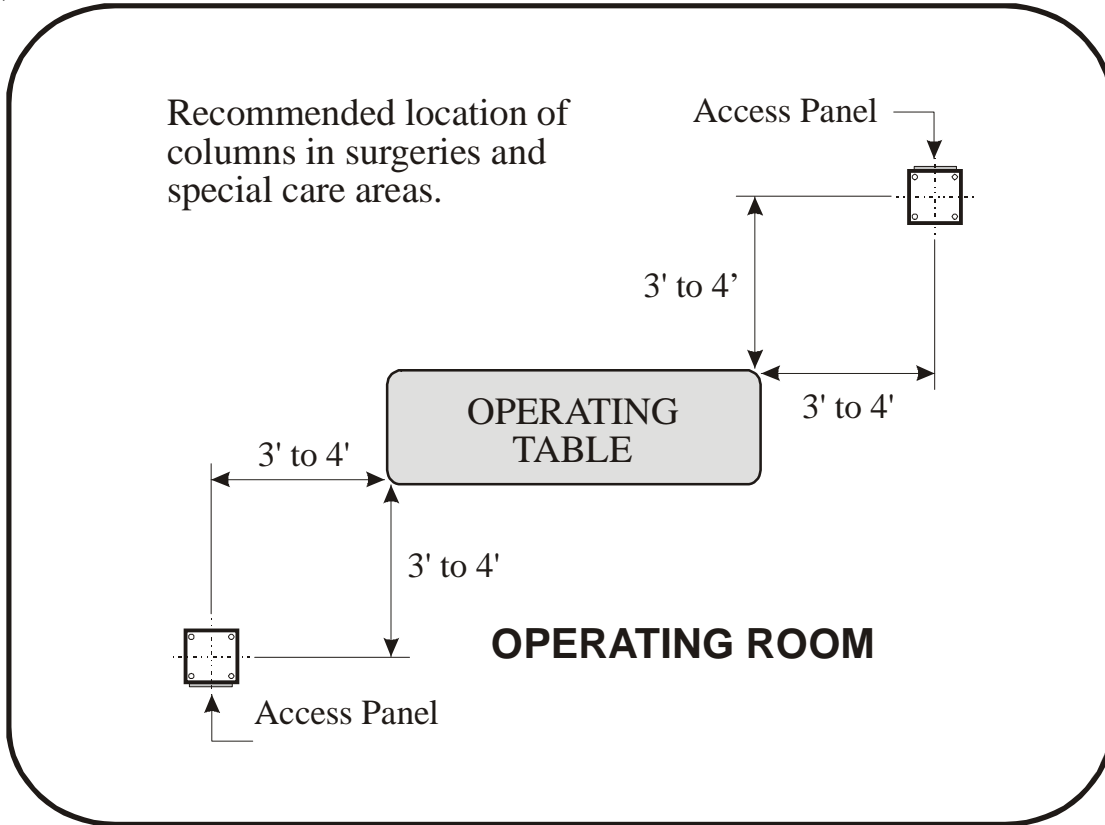

D I S T R I B U T E D B Y :

A_{Corporation}
AMICO 14 Madison Rd., Fairfield, NJ 07004 USA
85 Fulton Way, Richmond Hill, ON L4B 2N4 Canada

Tel: 1-877-GO AMICO (1-877-462-6426)
Fax: (905) 764-0862 www.amico.com