

# MANUAL RETRACTABLE CEILING COLUMN APPROVAL BOOKLET



## TABLE OF CONTENTS

Product Description .....	3
Cleaning .....	3
Inspection and Testing .....	3
Column Retraction .....	4
Elevation View .....	5
Optional Accessory Chart .....	6
Bottom View .....	7
Electrical Diagram .....	8
Mounting Plate to Outlet Detail .....	9
Mounting Information .....	10
Typical Location View .....	11

## PRODUCT DESCRIPTION

The manual retractable ceiling column shall be an Amico Alert-1 series.

The retractable ceiling column shall be of the manual operated type. The column shall consist of an upper section for rigid mounting at the ceiling level and a telescopic lower section capable of being extended to a maximum of 18 inches.

The retractable section of the column is activated by a coiled spring mechanism and can be lowered or raised at any position. The rotation of the handle will allow the column to become motionless or mobile. With the aid of an internal tracking system, the movement of the telescoping portion will glide freely up or down.

The upper and lower section shrouds are made of 16 gauge stainless steel with a # 4 satin finish and are complete with: Removable access panel, stainless steel ceiling collar and a heavy gauge steel mounting plate, equipped with hose assemblies (gas specific) within the internal shell of the column and brazed type copper fittings for all medical gas connections above the ceiling line.

All electrical and medical gas services are provided to the face of the lower section by means of flexible hoses and cables. All threaded connections comply with NFPA, CGA and DISS recommendations preventing interchanging of connections. All services are pre-assembled and factory tested. Standard dimensions are 13-9/16" X 13-9/16" for the upper section and 12" X 12" for the lower section.

NOTE: Electrical devices are pre-wired, unless otherwise stated.

## CLEANING

The Amico Outlets are factory cleaned for oxygen service. Exposed surfaces of the outlet may be cleaned with a mild detergent solution or wiped with a disinfectant commonly used in patient rooms that is compatible with plastics, anodized aluminium and die cast zinc.

## INSPECTION AND TESTING

Medical Gas Outlets should be inspected periodically or at least once a year. The test should be in accordance with NFPA 99-93 "*Gas and Vacuum systems*", or CSA Z305.1-92 "*Nonflammable Medical Gas Piping System*".

**Test for leaks:** Ensure that no leaks exist, with or without the adapter inserted.

**Test for Indexing:** Only a mating gas specific adapter should insert smoothly into the outlet, latch and be retained.

**Test for Flow:**

- Gas Outlets: 120 l/min (4.2 scfm) @ 345 kPa (50 psi), maximum allowable pressure drop is 28 kPa (4 psi).
- Nitrogen Outlet: 400 l/min (14.1 scfm) @ 1,250 kPa (180 psi), maximum allowable pressure drop is 70 kPa (10 psi).
- Vacuum Outlet: 30 l/min (1.1 scfm) @ 54 kPa (16 inHg), maximum allowable pressure drop is 13 kPa (4 inHg).

Refer to the appropriate standards for the proper way of performing the flow test.

Note: The Amico medical gas and vacuum outlets meet and exceed these requirements at the time of manufacture. However piping source capacity, sizing and restrictions may prevent outlets from attaining these values.

## MANUAL RETRACTABLE CEILING COLUMN RANGE OF COLUMN RETRACTION

To accommodate different ceiling heights, Amico Corporation has standardized three different variations.

The *LOW* height is designed for ceilings below 9'-0" (2743mm)

The *MEDIUM* height is designed for ceilings between 9'-1" (2769mm) and 9'-11" (3023mm)

The *HIGH* height is designed for ceilings above 10'-0" (3048mm)

Please select the column height below that applies to your application.

LOW



MEDIUM



HIGH

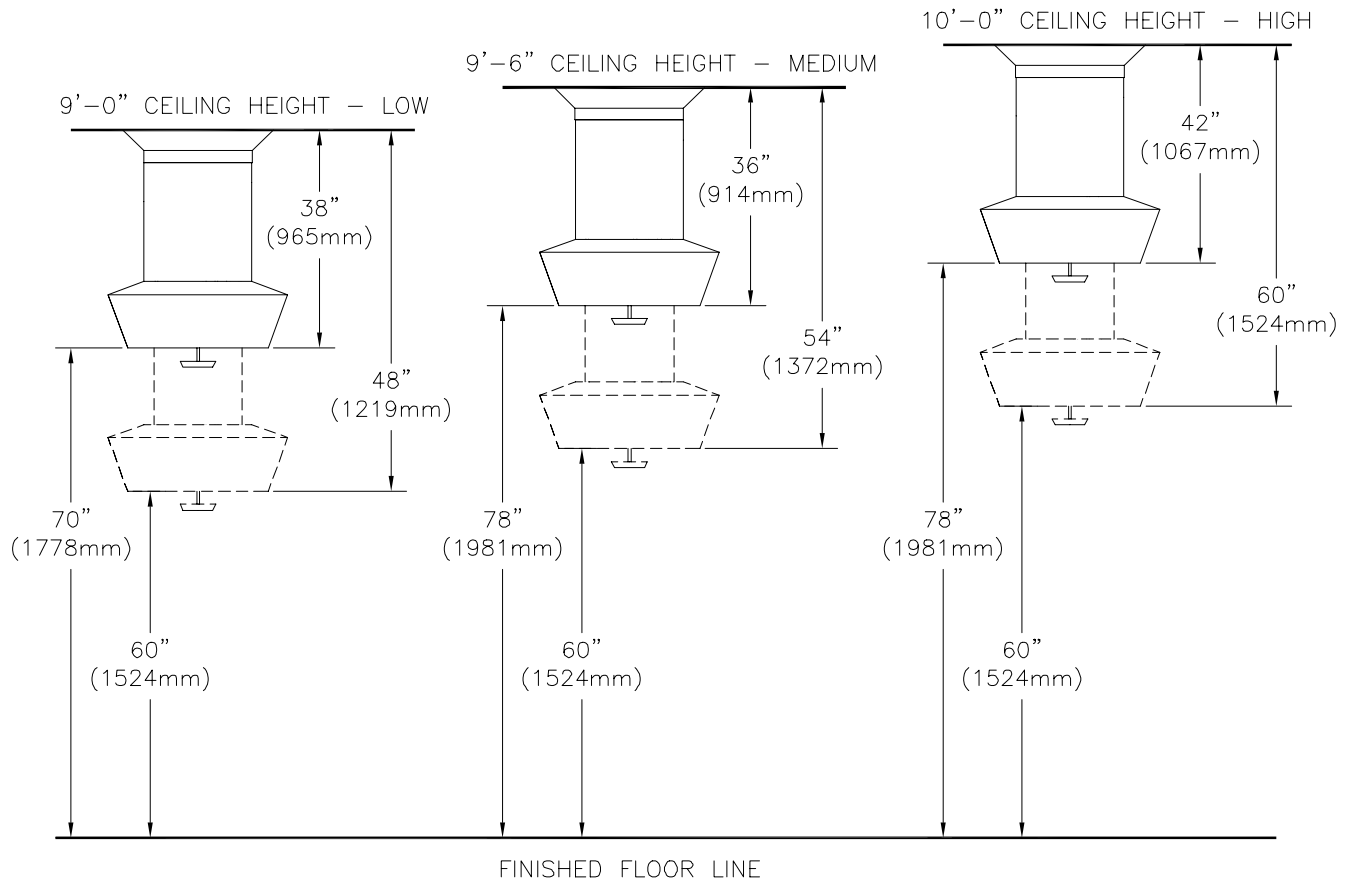

APPROVAL SIGNATURE \_\_\_\_\_

DATE \_\_\_\_\_

PHONE NO. \_\_\_\_\_

**Amico Corporation**  
85 Fulton Way  
Richmond Hill, Ontario  
L4B 2N4, CANADA  
Tel: (905) 764-0800  
Fax: (905) 764-0862  
www.amico.com

HOSPITAL

LOCATION

DRAWING NO:

MODEL:

MANUAL RETRACTABLE CEILING COLUMN

DESCRIPTION:

RANGE OF COLUMN RETRACTION

REVISION NUMBER: \_\_\_\_\_ DATE: \_\_\_\_\_

# MANUAL RETRACTABLE CEILING COLUMN ELEVATION VIEW

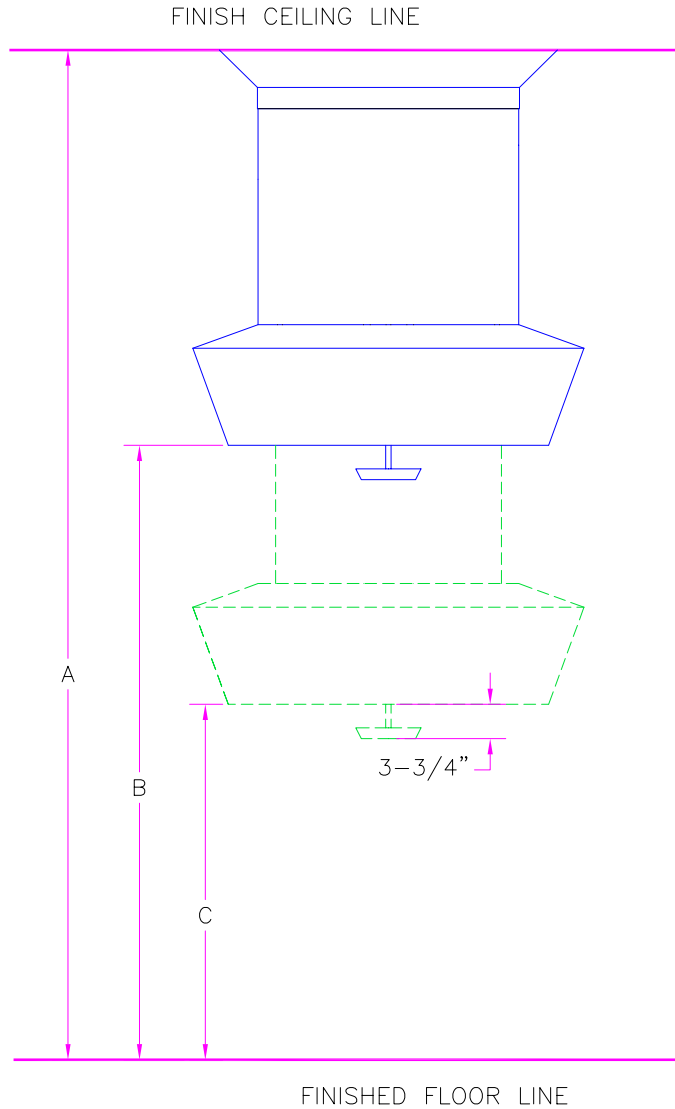

PLEASE PROVIDE THE FOLLOWING INFORMATION:

A=  
B=  
C=

QTY. =

APPROVAL SIGNATURE \_\_\_\_\_

DATE \_\_\_\_\_

PHONE NO. \_\_\_\_\_

**Amico Corporation**  
85 Fulton Way  
Richmond Hill, Ontario  
L4B 2N4, CANADA  
Tel: (905) 764-0800  
Fax: (905) 764-0862  
www.amico.com

HOSPITAL

LOCATION

DRAWING NO:

MODEL:







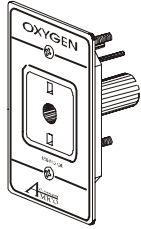
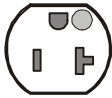
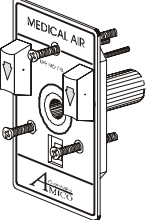
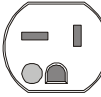

MANUAL RETRACTABLE CEILING COLUMN

DESCRIPTION:

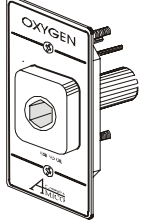
ELEVATION VIEW

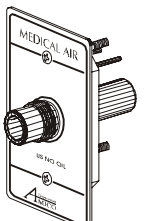
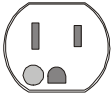
REVISION NUMBER: \_\_\_\_\_ DATE: \_\_\_\_\_

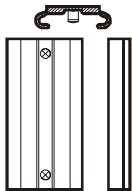
# OPTIONAL ACCESSORY CHART

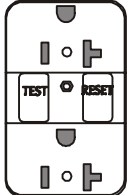
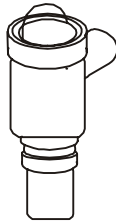
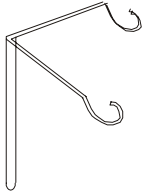
 <p style="text-align: right;"><b>QD XXX</b></p> <p style="text-align: center;">Ohmeda / Medaes Compatible</p>		 <p style="text-align: right;"><b>E9-RED E10-IVO.</b></p> <p style="text-align: center;">Duplex Receptacle 8300-HG 125V/20a (US / International)</p>
 <p style="text-align: right;"><b>CH XXX</b></p> <p style="text-align: center;">Chemetron Compatible</p>	 <p style="text-align: right;"><b>E3-RED E4-IVO.</b></p> <p style="text-align: center;">Single Receptacle 8310CN-HG 125V/20a (Canadian 15a)</p>	 <p style="text-align: right;"><b>E11-RED E12-IVO.</b></p> <p style="text-align: center;">Single Receptacle 8310-HG 125V/20a (US / International)</p>
 <p style="text-align: right;"><b>PB XXX</b></p> <p style="text-align: center;">Puritan-Bennett Compatible</p>	 <p style="text-align: right;"><b>E5-RED E6-IVO.</b></p> <p style="text-align: center;">Duplex Receptacle 8200-HG 125V/15a (US / International)</p>	 <p style="text-align: right;"><b>GJ</b></p> <p style="text-align: center;">Ground Jack Receptacle Single Hampden (SLR-3) GREEN</p>
 <p style="text-align: right;"><b>DI XXX</b></p> <p style="text-align: center;">DISS</p>	 <p style="text-align: right;"><b>E7-RED E8-IVO.</b></p> <p style="text-align: center;">Single Receptacle 8210-HG 125V/15a (US / International)</p>	 <p style="text-align: right;"><b>MJ</b></p> <p style="text-align: center;">Monitor Jack Duplex (5-pin shown)</p>
 <p style="text-align: right;"><b>SL</b></p> <p style="text-align: center;">Vacuum Bottle Slide</p>	 <p style="text-align: right;"><b>TL</b></p> <p style="text-align: center;">Twist-Lock Receptacle Hubble 23000-HG 125V/20a</p>	 <p style="text-align: right;"><b>E13-RED E14-IVO. E13C-RED E14C-IVO.</b></p> <p style="text-align: center;">Ground Fault Circuit Interrupter (C = Canadian)</p>
 <p style="text-align: right;"><b>EVAC</b></p> <p style="text-align: center;">Passive Evacuation with Impedance Valve (19mm/22mm)</p>	<p style="text-align: right;"><b>DJ</b></p> <p style="text-align: center;">Data - Telephone Communication Jack (Provision only)</p>	 <p style="text-align: right;"><b>IV</b></p> <p style="text-align: center;">Stainless Steel IV Hook (Duplex only)</p>

All electrical devices are HUBBELL brand

# MANUAL RETRACTABLE CEILING COLUMN BOTTOM VIEW

*ACCESS PANEL ON THIS SIDE*

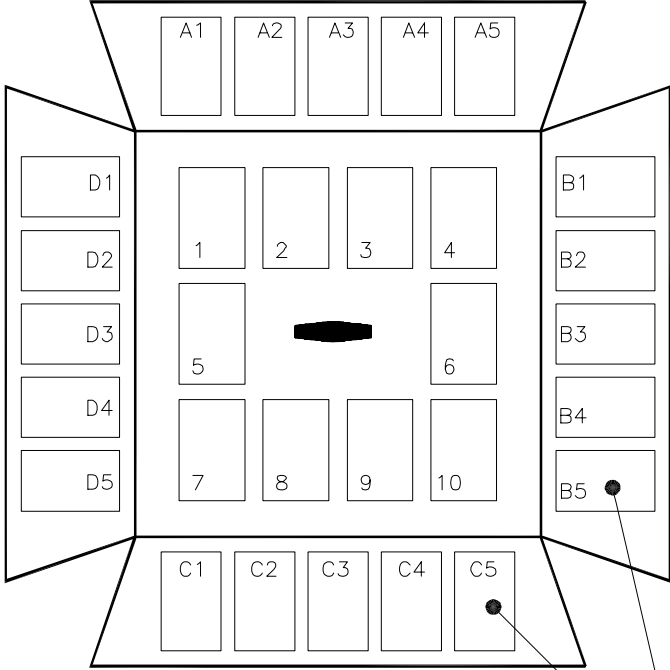

*BOTTOM VIEW  
LOOKING UP*

*"SEE NOTE NO. 1"*

**NOTE:**  
*TWO ELECTRICAL/COMMUNICATION DEVICES CANNOT  
BE PLACED TOGETHER AT ANY CORNER.*

*PLEASE FILL OUT THE OPTIONAL DEVICES THAT YOU REQUIRE FOR YOUR APPLICATION.*

\_\_\_\_\_  
APPROVAL SIGNATURE

\_\_\_\_\_  
DATE

\_\_\_\_\_  
PHONE NO.



www.amico.com

HOSPITAL

LOCATION

DRAWING NO:

MODEL:

MANUAL RETRACTABLE CEILING COLUMN

DESCRIPTION:

BOTTOM VIEW

REVISION NUMBER:\_\_\_\_ DATE:\_\_\_\_\_

# MANUAL RETRACTABLE CEILING COLUMN ELECTRICAL DIAGRAM

ACCESS PANEL ON THIS SIDE

CCT.# CCT.# CCT.# CCT.# CCT.#

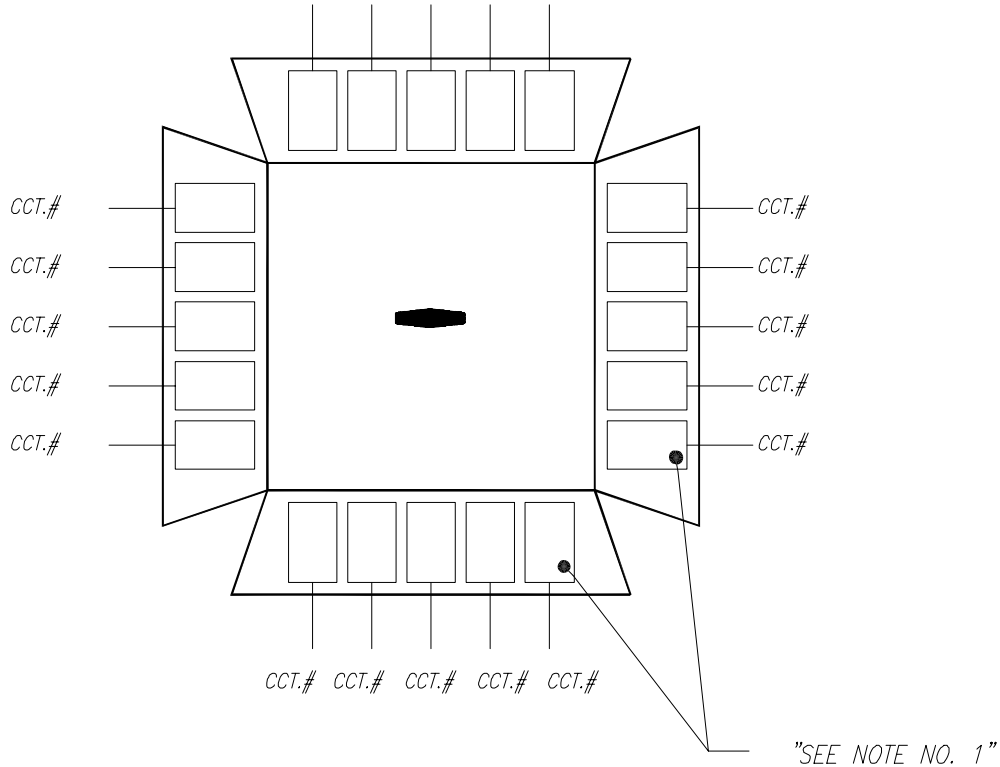

Pls. Specify Electrical Details:

-Type of Wire: \_\_\_\_\_

-AWG Wire Gauge: \_\_\_\_\_

-Circuit Number(CCT#) for each receptacle.

NOTE:

1. TWO ELECTRICAL/COMMUNICATION DEVICES CANNOT BE PLACED TOGETHER AT ANY CORNER.
2. IF TYPE OF WIRE & SIZE IS NOT SPECIFIED USE THE FOLLOWING:  
FOR US/INTERNATIONAL  
- 12 Ga. THHN WIRE (STD. WIRING)  
- 10 Ga. THHN WIRE (ALL GROUNDS)  
FOR CANADA:  
- 12 Ga. RW90 WIRE (STD. WIRING)  
- 10 Ga. RW90 WIRE (ALL GROUNDS)
3. CONDUIT: 1/2" FLEXIBLE CONDUIT.
4. ALL CONDUITS AND WIRES WILL EXTEND 36" ABOVE FINISH COLUMN FOR CONNECTION TO MAIN SOURCE.

APPROVAL SIGNATURE \_\_\_\_\_

DATE \_\_\_\_\_

PHONE NO. \_\_\_\_\_

**AMICO** Corporation  
85 Fulton Way  
Richmond Hill, Ontario  
L4B 2N4, CANADA  
Tel: (905) 764-0800  
Fax: (905) 764-0862  
www.amico.com

HOSPITAL \_\_\_\_\_

LOCATION \_\_\_\_\_

DRAWING NO: \_\_\_\_\_

MODEL:

MANUAL RETRACTABLE CEILING COLUMN

DESCRIPTION:

ELECTRICAL DIAGRAM

REVISION NUMBER: \_\_\_\_\_ DATE: \_\_\_\_\_

# MANUAL RETRACTABLE CEILING COLUMN

## RISER PLATE TO OUTLET DETAIL

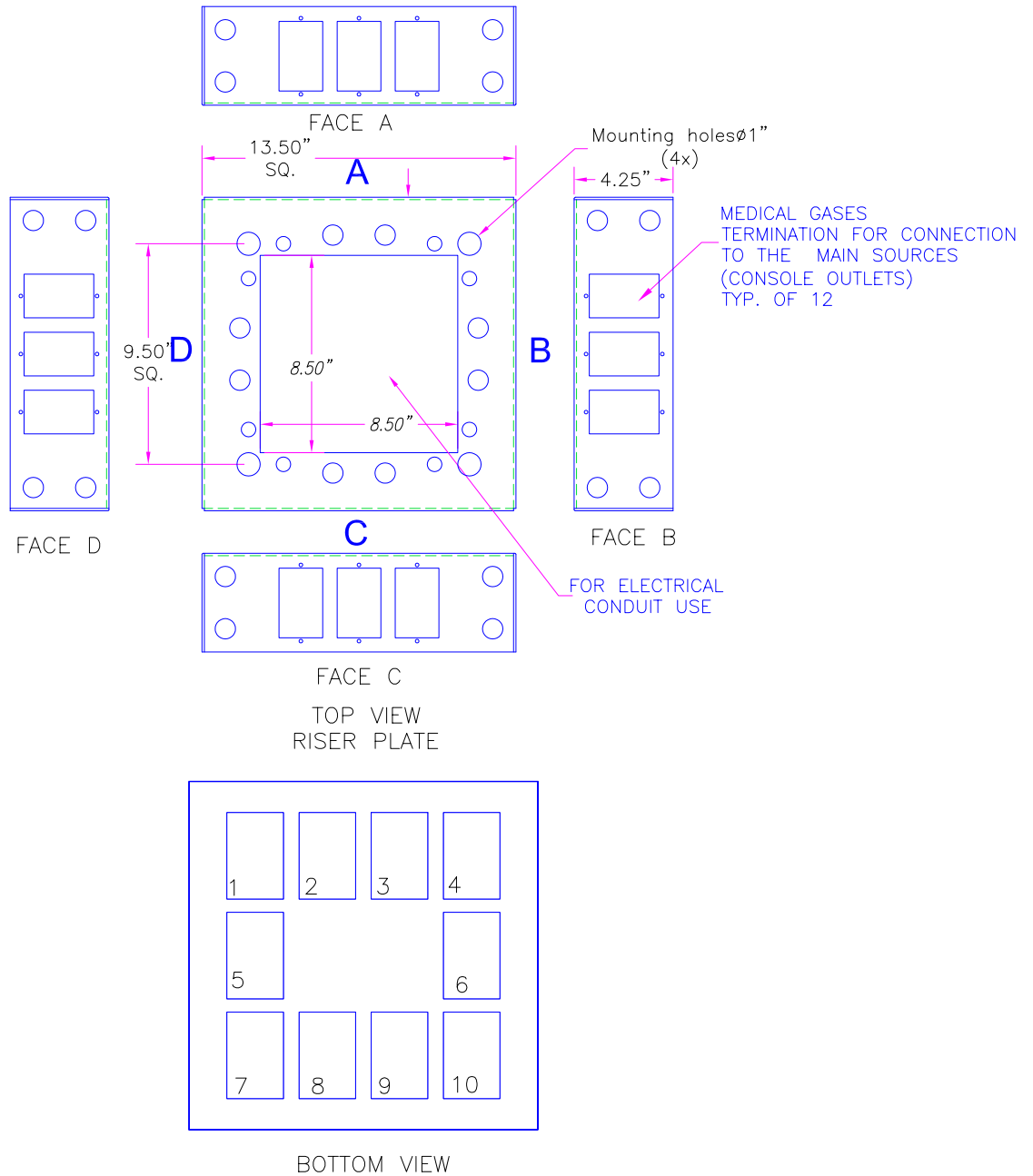

**NOTE:**

1. RISER PLATE IS COMPLETED WITH DISS CONSOLE OUTLETS, TYPICAL FOR EACH GAS.
2. PIPE STUBS DIAMETERS ARE 3/8" FOR ALL GASES.
3. EXACT LOCATIONS OF GAS TERMINATIONS ON MOUNTING PLATE WILL BE DETERMINED AFTER RECEIVING THIS BOOKLET. AMICO WILL FOLLOW ASAP WITH A COMPLETE "MOUNTING PLATE TO OUTLET DETAIL" DIAGRAM, SHOWING EXACT LOCATIONS FOR GAS TERMINATIONS.

APPROVAL SIGNATURE \_\_\_\_\_

DATE \_\_\_\_\_

PHONE NO. \_\_\_\_\_

**AMICO Corporation**  
 85 Fulton Way  
 Richmond Hill, Ontario  
 L4B 2N4, CANADA  
 Tel: (905) 764-0800  
 Fax: (905) 764-0862  
 www.amico.com

HOSPITAL \_\_\_\_\_

LOCATION \_\_\_\_\_

DRAWING NO: \_\_\_\_\_

MODEL:

MANUAL RETRACTABLE CEILING COLUMN

DESCRIPTION:

MOUNTING PLATE TO OUTLET DETAIL

REVISION NUMBER: \_\_\_\_\_ DATE: \_\_\_\_\_

## MANUAL RETRACTABLE CEILING COLUMN MOUNTING INFORMATION

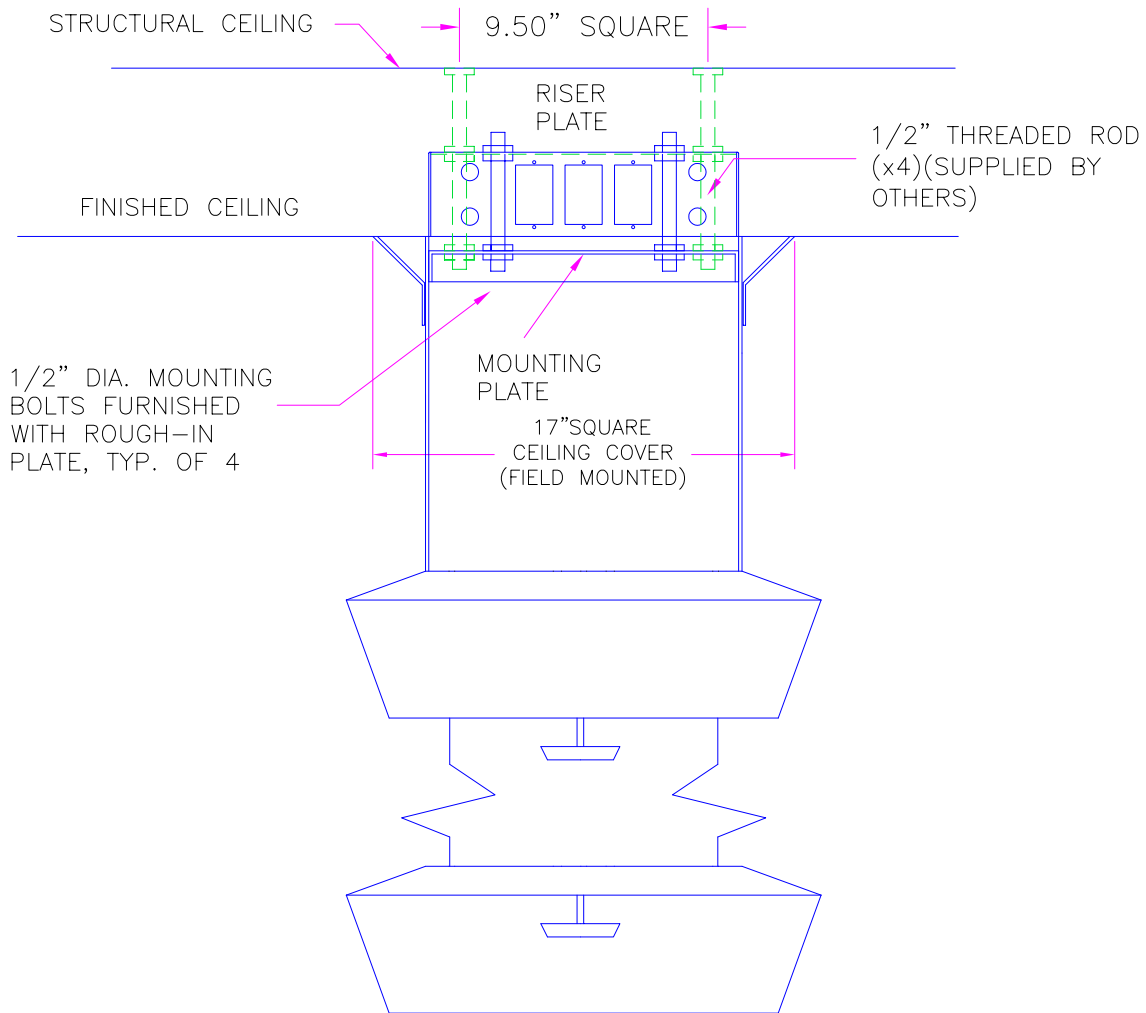

**NOTES**

1. 1/2" Support rods located for total support of fixture (minimum 400lb. load), all labor and materials for support fabrication including nuts and washers for installation supplied by General Contractor.
2. General Contractor has final responsibility for the strength and stability of the mounting structure.
3. Mounting structure and all hardware necessary supplied by General Contractor.

APPROVAL SIGNATURE \_\_\_\_\_

DATE \_\_\_\_\_

PHONE NO. \_\_\_\_\_

**AMICO Corporation**  
 85 Fulton Way  
 Richmond Hill, Ontario  
 L4B 2N4, CANADA  
 Tel: (905) 764-0800  
 Fax: (905) 764-0862  
 www.amico.com

HOSPITAL	MODEL: MANUAL RETRACTABLE CEILING COLUMN
LOCATION	DESCRIPTION: MOUNTING INFORMATION
DRAWING NO:	REVISION NUMBER: _____ DATE: _____

# TYPICAL LOCATION VIEW

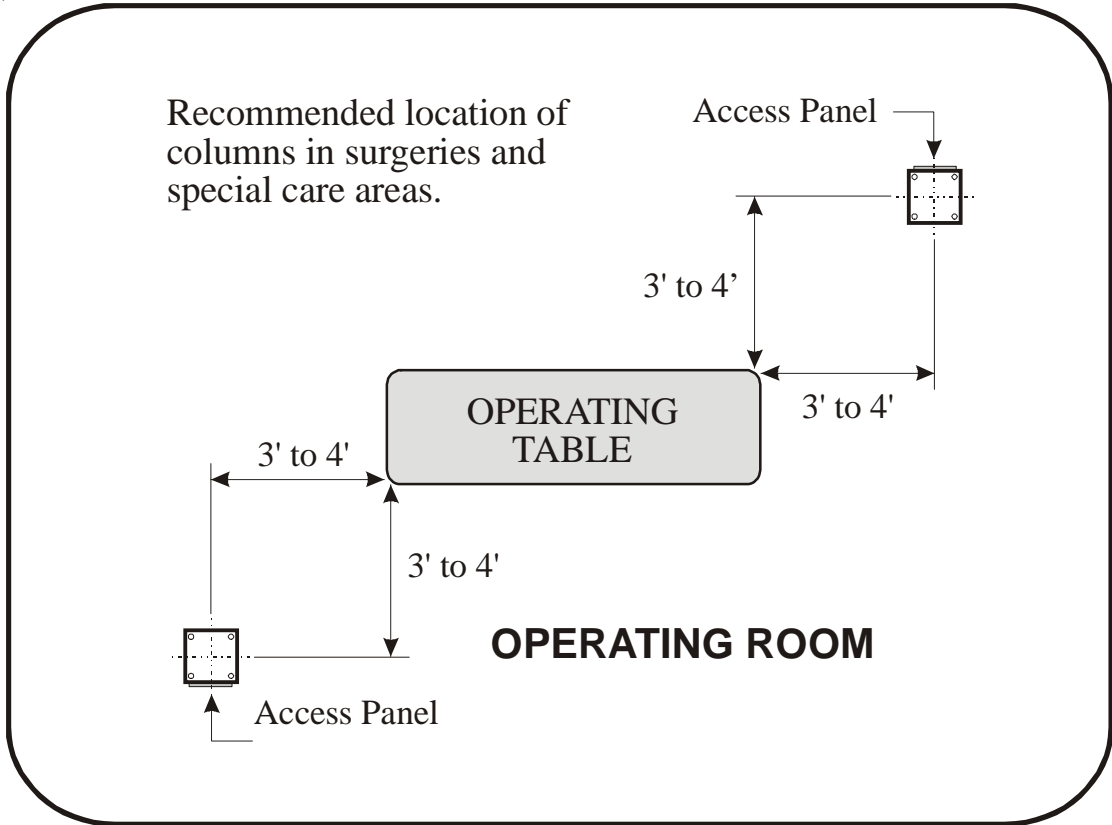

D I S T R I B U T E D   B Y :

**A** *Corporation*  
**AMICO** 14 Madison Rd., Fairfield, NJ 07004 USA  
85 Fulton Way, Richmond Hill, ON L4B 2N4 Canada

Tel: 1-877-GO AMICO (1-877-462-6426)  
Fax: (905) 764-0862 [www.amico.com](http://www.amico.com)